



Renesas Starter Kit
RSKM16C6NK User's Manual

RENESAS SINGLE-CHIP MICROCOMPUTER

M16C FAMILY

Table of Contents

Chapter 1. Preface	1
Chapter 2. Purpose	2
Chapter 3. Power Supply	3
3.1. Requirements	3
3.2. Power – Up Behaviour	3
Chapter 4. Board Layout	4
4.1. Component Layout	4
4.2. Board Dimensions	5
Chapter 5. Block Diagram	6
Chapter 6. User Circuitry.....	7
6.1. Switches	7
6.2. LEDs.....	7
6.3. Potentiometer	7
6.4. Serial port	8
6.5. LCD Module.....	8
6.6. Option Links.....	9
6.7. Oscillator Sources	15
6.8. Reset Circuit.....	15
Chapter 7. Modes.....	16
7.1. Boot mode.....	16
7.2. Single chip mode	16
Chapter 8. Programming Methods.....	17
Chapter 9. Headers.....	18
9.1. Microcontroller Headers	18
9.2. Application Headers	20
Chapter 10. Code Development	24
10.1. Overview.....	24
10.2. Mode Support.....	24
10.3. Breakpoint Support.....	24
10.4. Memory Map.....	25
Chapter 11. Component Placement.....	26
Chapter 12. Additional Information.....	27

Chapter 1. Preface

Cautions

This document may be, wholly or partially, subject to change without notice.

All rights reserved. Duplication of this document, either in whole or part is prohibited without the written permission of Renesas Technology Europe Limited.

Trademarks

All brand or product names used in this manual are trademarks or registered trademarks of their respective companies or organisations.

Copyright

© Renesas Technology Europe Ltd. 2007. All rights reserved.

© Renesas Solutions Corporation. 2007. All rights reserved.

© Renesas Technology Corporation. 2007. All rights reserved.

Website: <http://www.eu.renesas.com/>

Glossary

CPU	Central Processing Unit	RTE	Renesas Technology Europe Ltd.
HEW	High-performance Embedded Workshop	RSO	Renesas Solutions Organisation.
LED	Light Emitting Diode	RSK	Renesas Starter Kit
PC	Program Counter	E8a	E8a On-chip debugger module

Chapter 2. Purpose

This RSK is an evaluation tool for Renesas microcontrollers.

Features include:

- Renesas Microcontroller Programming.
- User Code Debugging.
- User Circuitry such as Switches, LEDs and potentiometer(s).
- User or Example Application.
- Sample peripheral device initialisation code.

The RSK board contains all the circuitry required for microcontroller operation.

Chapter 3. Power Supply

3.1. Requirements

This RSK operates from a 5V power supply.

A diode provides reverse polarity protection only if a current limiting power supply is used.

RSK boards are supplied with an E8a debugger module. This product is able to power the RSK board with up to 300mA. When the RSK is connected to another system then that system should supply power to the RSK.

All RSK boards have an optional centre positive supply connector using a 2.1mm barrel power jack.

Warning

The RSK is neither under nor over voltage protected. Use a centre positive supply for this board.

3.2. Power – Up Behaviour

When the RSK is purchased the RSK board has the 'Release' or stand alone code from the example tutorial code pre-programmed into the Renesas microcontroller. On powering up the board the user LEDs will start to flash. After 200 flashes, or after pressing a switch the LEDs will flash at a rate controlled by the potentiometer.

Chapter 4. Board Layout

4.1. Component Layout

The following diagram shows the top layer component layout of the board.

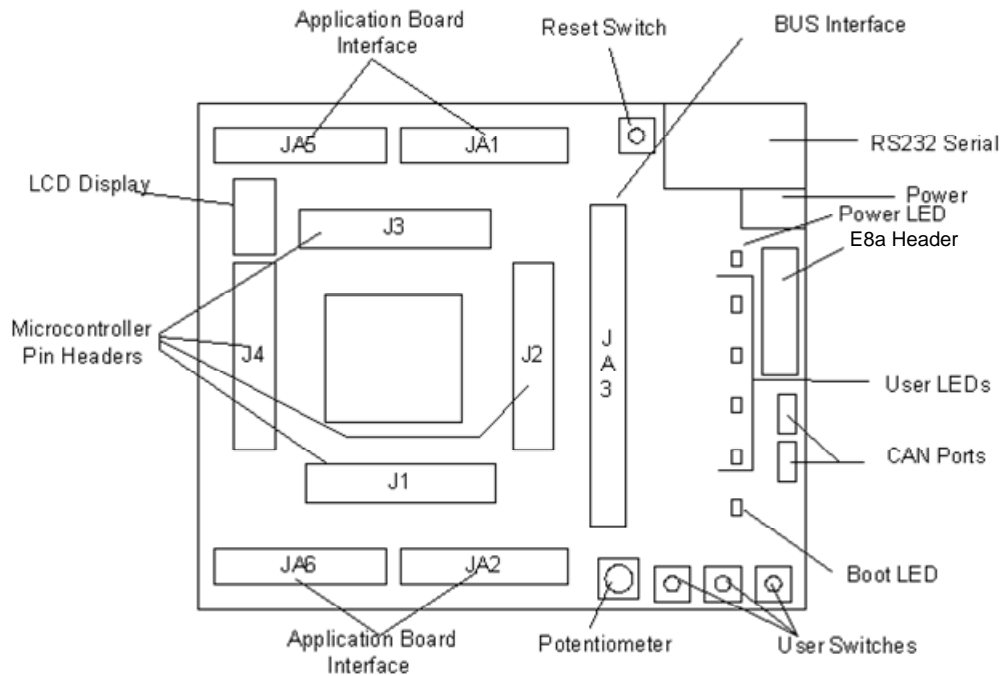

Figure 4-1: Board Layout

4.2. Board Dimensions

The following diagram gives the board dimensions and connector positions. All through hole connectors are on a common 0.1" grid for easy interfacing.

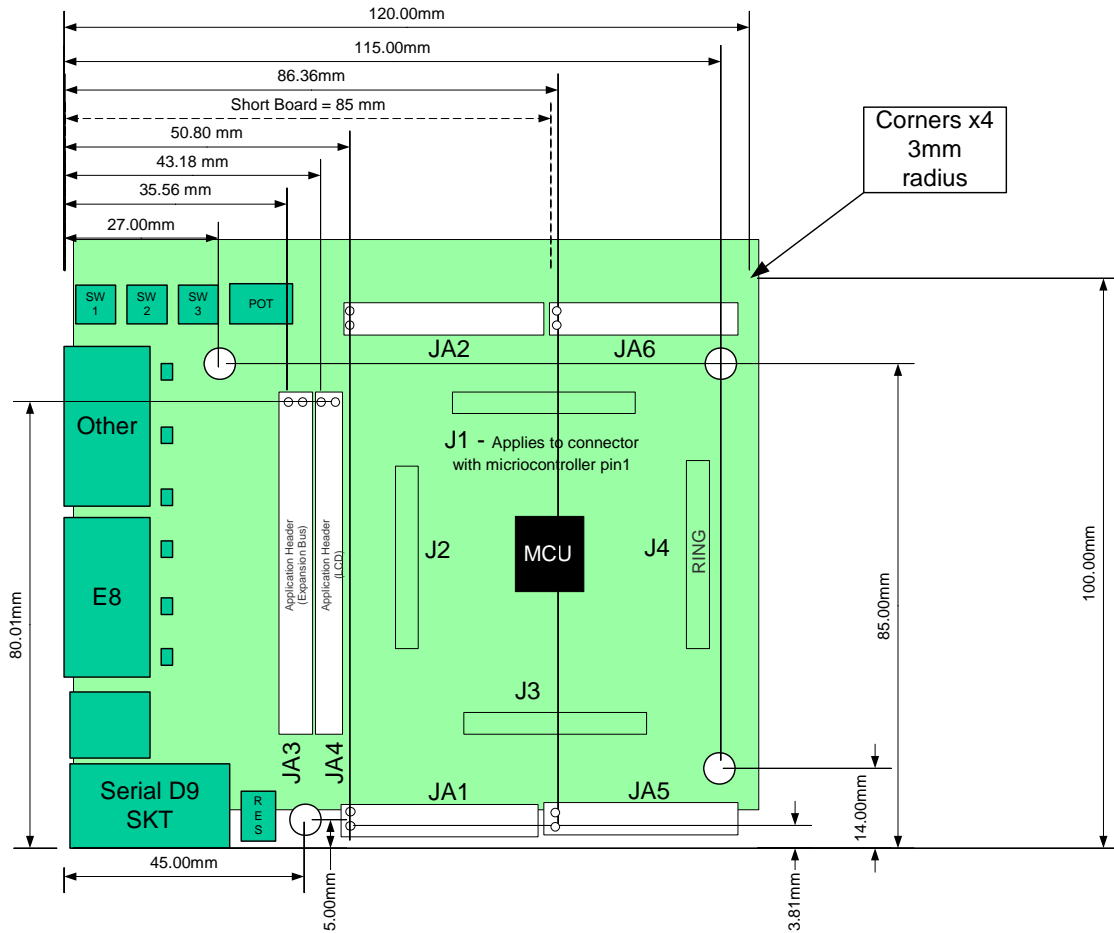

Figure 4-2 : Board Dimensions

Chapter 5. Block Diagram

Figure 5-1 is representative of the CPU board components and their connectivity.

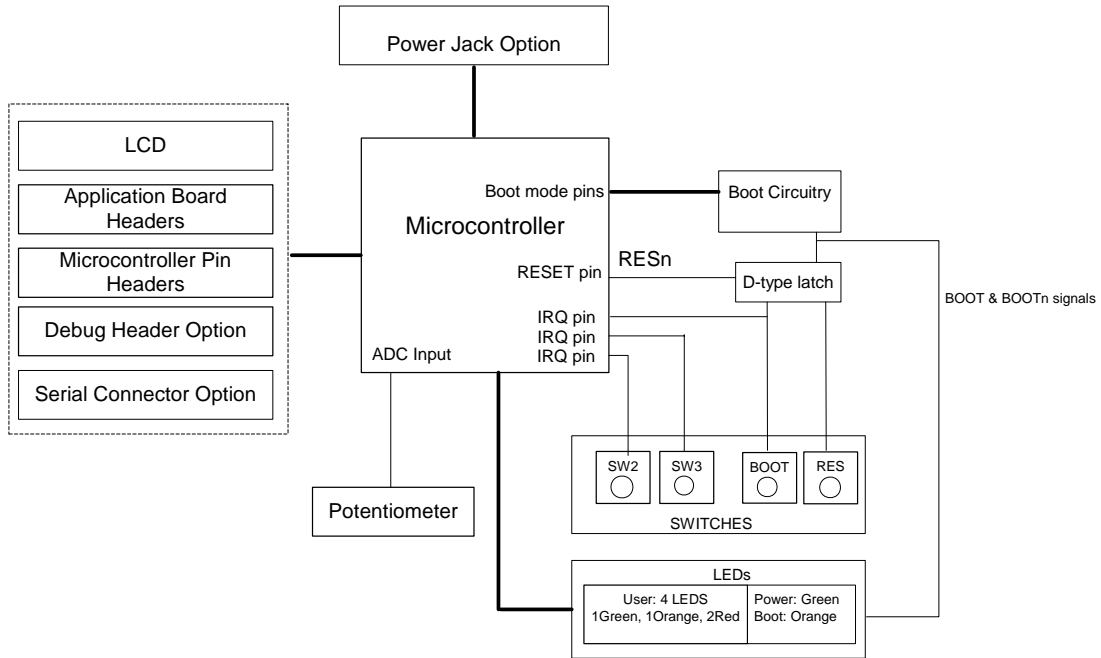

Figure 5-1: Block Diagram

Figure 5-2 is representative of the connections required to the RSK.

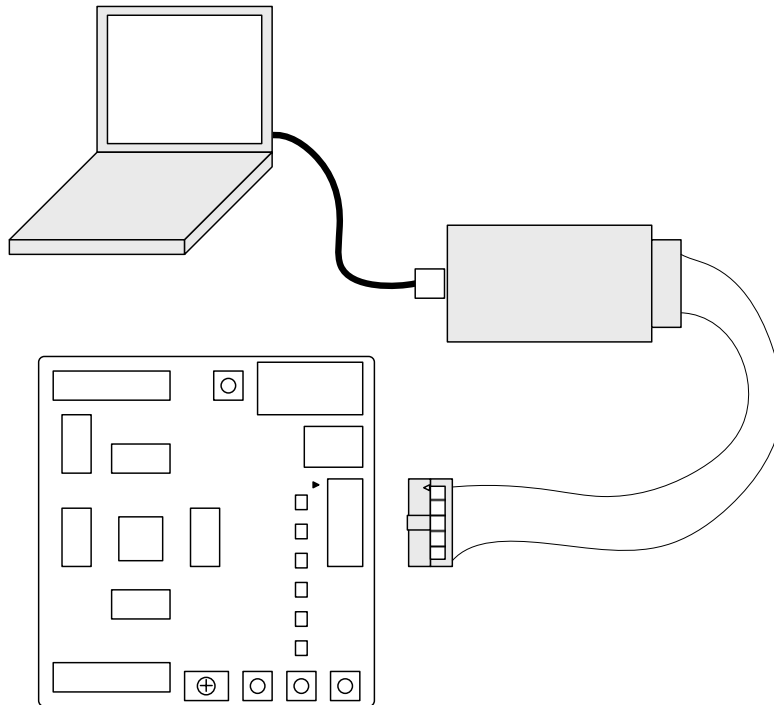

Figure 5-2 : RSK Connections

Chapter 6. User Circuitry

6.1. Switches

There are four switches located on the RSK. The function of each switch and its connection are shown in Table 6-1.

Switch	Function	Microcontroller
RES	When pressed the RSK microcontroller is reset.	RESn
SW1/BOOT*	Connects to an IRQ input for user controls. The switch is also used in conjunction with the RES switch to place the device in BOOT mode when not using the E8a module.	INT0 Pin18 (Port 8, pin 2)
SW2*	Connects to an IRQ line for user controls.	INT1 Pin17 (Port 8, pin 3)
SW3*	Connects to the ADC trigger input. Option link allows connection to IRQ line. The option is a pair of OR links.	ADTRG Pin 98 (Port 9, pin 7) OR INT2 Pin16 (Port 8, pin 4)

Table 6-1: Switch Functions

*Refer to schematic for detailed connectivity information.

6.2. LEDs

There are six LEDs on the RSK board. The green 'POWER' LED lights when the board is powered. The orange BOOT LED indicates the device is in BOOT mode when lit. The four user LEDs are connected to an IO port and will light when their corresponding port pin is set low.

Table 6-2, below, shows the LED pin references and their corresponding microcontroller port pin connections.

LED Reference (As shown on silkscreen)	Microcontroller Port Pin function	Microcontroller Pin Number
LED0	Port 4.0	52
LED1	Port 4.1	51
LED2	Port 4.2	50
LED3	Port 4.3	49

Table 6-2: LED Port

6.3. Potentiometer

A single turn potentiometer is connected to AN0.0 (P10.0) of the microcontroller. This may be used to vary the input analogue voltage value to this pin between AVCC and Ground.

6.4. Serial port

The microcontroller programming serial port 1 is connected to the RS232 connector. A serial port can be used by moving option resistors and fitting the D connector. This can be connected to serial channel 1 if the E8a is disabled from using channel 1; or serial channel 0 while the E8a is enabled.

Description	Function	Fit For E8a	Remove for E8a	Fit for RS232 Channel 0	Remove for RS232 Channel 0	Fit for RS232 Channel 1	Remove for RS232 Channel 1
TxD1	Programming Serial Port	R13	R68	R69	R68	R68	R69, R13
RxD1	Programming Serial Port	R12	R44	R47	R44	R44	R47, R12
CLK1	Programming Serial Port	R14	NA	NA	NA	NA	R14

Table 6-3: Serial port connections

If a serial port is used the D-connector U3 must be fitted and the RS232 transceiver enabled.

Description	Function	Fit For RS233 Enable	Remove for RS233 Enable	Fit For RS233 Disable	Remove for RS233 Disable
RS232 Transceiver Enable	Disables/Enables U3 RS232 Transceiver	R42	R39	R39	R42

Table 6-4: RS232 enable

An additional serial port is connected to the application headers.

6.5. LCD Module

An LCD module is supplied to be connected to the connector J11. This should be fitted so that the LCD module lies over J3. Care should be taken to ensure the pins are inserted correctly into J11. The LCD module uses a 4 bit interface to reduce the pin allocation. No contrast control is provided; this is set by a resistor on the supplied display module. The module supplied with the RSK only supports 5V operation.

Table 6-5 shows the pin allocation and signal names used on this connector.

J11					
Pin	Circuit Net Name	Device Pin	Pin	Circuit Net Name	Device Pin
1	Ground	-	2	5V Only	-
3	No Connection	-	4	DLCDRS	70
5	R/W (Wired to Write only)	-	6	DLCDE	69
7	No Connection	-	8	No Connection	-
9	No Connection	-	10	No Connection	-
11	DLCD4	66	12	DLCD5	65
13	DLCD6	64	14	DLCD7	63

Table 6-5: LCD Module Connections

6.6. Option Links

Table 6-6 below describes the function of the option links associated with Power configuration. The default configuration is indicated by BOLD text.

Option Link Settings				
Reference	Function	Fitted	Alternative (Removed)	Related To
R9	Board VCC	Supply to board from J5	Fit Low ohm resistor to measure current	
R32	Microcontroller VCC1	Supply to microcontroller VCC1	Fit Low ohm resistor to measure current	R33
R33	Microcontroller VCC2	Supply to microcontroller VCC2	Fit Low ohm resistor to measure current	R32
R25	Board VCC1	Board VCC1 connected to Connector 3V3	Disconnected	R23,28
R28	Board VCC1	Board VCC1 connected to Connector 5V	Disconnected	R23,R25
R23	Board VCC1	Board VCC1 connected to Connector J5	Disconnected	R25,R28
R26	Board VCC2	Board VCC2 connected to Connector 3V3	Disconnected	R24,29
R29	Board VCC2	Board VCC2 connected to Connector 5V	Disconnected	R24,R26
R24	Board VCC2	Board VCC2 connected to Connector J5	Disconnected	R26,R29

Table 6-6: Power Configuration Links

Table 6-7 below describes the function of the option links associated with Clock configuration. The default configuration is indicated by BOLD text.

Option Link Settings				
Reference	Function	Fitted	Alternative (Removed)	Related To
R96	External Oscillator	Connects External Ring header pins to Microcontroller	Disconnects sensitive microcontroller signals from external pins.	R100
R100	External Oscillator	Connects External Ring header pins to Microcontroller	Disconnects sensitive microcontroller signals from external pins.	R96
R97	External Oscillator	Parallel resistor for crystal	Not fitted	
R103	External Subclock Oscillator	Connects External Ring header pins to Microcontroller	Disconnects sensitive microcontroller signals from external pins.	R105
R105	External Subclock Oscillator	Connects External Ring header pins to Microcontroller	Disconnects sensitive microcontroller signals from external pins.	R103
R106	External Subclock Oscillator	Parallel resistor for crystal	Not fitted	

Table 6-7: Clock Configuration Links

Table 6-8 below describes the function of the option links associated with Serial configuration. The default configuration is indicated by BOLD text.

Option Link Settings				
Reference	Function	Fitted	Alternative (Removed)	Related To
R14	Programming Serial Port	Connects SCK to E8a	SCK disconnected from E8a	
R12	Programming Serial Port	Connects E8a to Programming Serial port.	MUST be removed if R44 fitted.	R44
R13	Programming Serial Port	Connects E8a to Programming Serial port.	Should be removed if R68 fitted.	R68
R44	Programming Serial Port	Connects RS232 port to Programming SCI port	MUST be removed if R12, R47 or R49 fitted.	R12, R47, R49
R68	Programming Serial Port	Connects RS232 port to Programming SCI port	MUST be removed if R13, R69 or R72 fitted.	R13, R69, R72
R42	RS232 Driver	Enables RS232 Serial Transceiver	MUST be removed if R39 Fitted	R39
R39	RS232 Driver	Disables RS232 Serial Transceiver	MUST be removed if R42 Fitted	R42
R41	Serial Connector	Connects Alternate serial (CH2) to D connector	Disconnects Alternate serial from D connector.	R40
R40	Serial Connector	Connects Alternate serial (CH2) to D connector	Disconnects Alternate serial from D connector.	R41
R55	Alternate Serial	Connects Alternate Serial (CH2 - SC1b) to RS232 Transceiver	Should be removed if SC1b not used for RS232.	R50
R50	Alternate Serial	Connects Alternate Serial (CH2 - SC1b) to RS232 Transceiver	Should be removed if SC1b not used for RS232.	R55
R72	RS232 Serial on Application Header	Connects Application Header to RS232 Transceiver	MUST be removed if R68 or R69 fitted.	R68, R69
R49	RS232 Serial on Application Header	Connects Application Header to RS232 Transceiver	MUST be removed if R44 or R47 fitted.	R44, R47
R69	RS232 Serial on SC1a CH0	Connects Serial Channel 0 to RS232 Transceiver	MUST be removed if R68 or R72 fitted.	R68, R72
R47	RS232 Serial on SC1a CH0	Connects Serial Channel 0 to RS232 Transceiver	MUST be removed if R44 or R49 fitted.	R44, R49

Table 6-8: Serial Configuration Links

Table 6-9 below describes the function of the option links associated with Analog configuration. The default configuration is indicated by **BOLD** text.

Option Link Settings				
Reference	Function	Fitted	Alternative (Removed)	Related To
R31	Analogue Power	Connects Board VCC1 supply to Analogue supply	Analogue supply MUST be provided from external interface pins. (Fit R43)	JA1,R43
R43	Analogue Power	Connects AVCC supply to Application headers	R31 must be fitted	R31
R109	VREF	Connects Board VCC1 supply to VREF	VREF can be provided from external interface pins. (Fit R110)	JA1,R110
R110	VREF	VREF to Application headers	R109 should be fitted	R109

Table 6-9: Analog Configuration Links

Table 6-10 below describes the function of the option links associated with microcontroller pin function select configuration. The default configuration is indicated by **BOLD** text.

Option Link Settings				
Reference	Function	Fitted	Alternative (Removed)	Related To
R82	Microcontroller pin function select	Connects microcontroller pin 28 to IICSDA	MUST be removed if R80 fitted.	R80
R80	Microcontroller pin function select	Connects microcontroller pin 28 to TXD2 pin	Should be removed if R82 fitted.	R82
R78	Microcontroller pin function select	Connects microcontroller pin 27 to IICSCSCL	MUST be removed if R80 fitted.	R76
R76	Microcontroller pin function select	Connects microcontroller pin 27 to RXD2	Should be removed if R78 fitted.	R78
R114	Microcontroller pin function select	Connects microcontroller pin 95 to ADPOT	MUST be removed if R115 fitted.	R115
R115	Microcontroller pin function select	Connects microcontroller pin 95 to AN0	Should be removed if R114 fitted.	R114
R60	Microcontroller pin function select	Connects microcontroller pin 44 to Wrn pin	MUST be removed if R61 fitted.	R61
R61	Microcontroller pin function select	Connects microcontroller pin 44 to WRLn pin	Should be removed if R60 fitted.	R60
R94	Microcontroller pin function select	Connects microcontroller pin 20 to TA4OUT pin	MUST be removed if R93 fitted.	R93
R93	Microcontroller pin function select	Connects microcontroller pin 20 to Up pin	Should be removed if R94 fitted.	R94
R92	Microcontroller pin function select	Connects microcontroller pin 19 to TA4IN pin	MUST be removed if R92 fitted.	R90
R90	Microcontroller pin function select	Connects microcontroller pin 19 to Un pin	Should be removed if R92 fitted.	R92
R84	Microcontroller pin function select	Connects microcontroller pin 26 to CLK2 pin	MUST be removed if R83 fitted.	R90
R83	Microcontroller pin function select	Connects microcontroller pin 26 to Vp pin	Should be removed if R84 fitted.	R92
R87	Microcontroller pin function select	Connects microcontroller pin 24 to TA2OUT pin	MUST be removed if R85 fitted.	R87
R85	Microcontroller pin function select	Connects microcontroller pin 24 to Wp pin	Should be removed if R87 fitted.	R85
R88	Microcontroller pin function select	Connects microcontroller pin 23 to TA2IN pin	MUST be removed if R86 fitted.	R86
R86	Microcontroller pin function select	Connects microcontroller pin 23 to Wn pin	Should be removed if R88 fitted.	R88

Option Link Settings				
Reference	Function	Fitted	Alternative (Removed)	Related To
R128	Microcontroller pin function select	Connects microcontroller pin 47 to A21 pin	MUST be removed if R130 fitted.	R130
R130	Microcontroller pin function select	Connects microcontroller pin 47 to CS2N pin	Should be removed if R128 fitted.	R128
R118	Microcontroller pin function select	Connects microcontroller pin 46 to A22 pin	MUST be removed if R116 fitted.	R116
R116	Microcontroller pin function select	Connects microcontroller pin 46 to CS1N pin	Should be removed if R118 fitted.	R118
R131	Microcontroller pin function select	Connects microcontroller pin 90 to AN4 pin	MUST be removed if R129 fitted.	R129
R129	Microcontroller pin function select	Connects microcontroller pin 90 to CAN0 EN pin	Should be removed if R131 fitted.	R131
R117	Microcontroller pin function select	Connects microcontroller pin 89 to AN5 pin	MUST be removed if R117 fitted.	R119
R119	Microcontroller pin function select	Connects microcontroller pin 89 to CAN0 STBn pin	Should be removed if R119 fitted.	R117
R67	Microcontroller pin function select	Connects microcontroller pin 88 to AN6 pin	MUST be removed if R66 fitted.	R66
R66	Microcontroller pin function select	Connects microcontroller pin 88 to CAN1 EN pin	Should be removed if R67 fitted.	R67
R45	Microcontroller pin function select	Connects microcontroller pin 87 to AN7 pin	MUST be removed if R46 fitted.	R46
R46	Microcontroller pin function select	Connects microcontroller pin 87 to CAN1 STBn pin	Should be removed if R45 fitted.	R45

Table 6-10: MCU Pin Function Select Configuration Links

Table 6-11 below describes the function of the option links associated with other options. The default configuration is indicated by **BOLD** text.

Option Link Settings				
Reference	Function	Fitted	Alternative (Removed)	Related To
R35	SW3	Connects SW3 to Analogue Trigger input	Disconnected	R34
R34	SW3	Connects SW3 to INT2 input	Disconnected	R35

Table 6-11: Other Option Links

6.7. Oscillator Sources

A crystal oscillator is fitted on the RSK and used to supply the main clock input to the Renesas microcontroller. Table 6-12 details the oscillators that are fitted and alternative footprints provided on this RSK:

Component		
Crystal (X1)	Fitted	10MHz (HC/49U package)
Subclock (X2)	Fitted	32.768kHz (90SMX package)

Table 6-12: Oscillators / Resonators

6.8. Reset Circuit

The CPU Board includes a simple latch circuit that links the mode selection and reset circuit. This provides an easy method for swapping the device between Boot Mode, User Boot Mode and User mode. This circuit is not required on customers boards as it is intended for providing easy evaluation of the operating modes of the device on the RSK. Please refer to the hardware manual for more information on the requirements of the reset circuit.

The Reset circuit operates by latching the state of the boot switch on pressing the reset button. This control is subsequently used to modify the mode pin states as required.

The mode pins should change state only while the reset signal is active to avoid possible device damage.

The reset is held in the active state for a fixed period by a pair of resistors and a capacitor. Please check the reset requirements carefully to ensure the reset circuit on the user's board meets all the reset timing requirements.

Chapter 7. Modes

The RSK supports Boot mode and Single chip mode.

Details of programming the FLASH memory is described in the M16C/6NK Group Hardware Manual.

7.1. Boot mode

The boot mode settings for this RSK are shown in Table 7-1: Boot Mode pin settings below:

CNVSS	P5.0	P5.5	LSI State after Reset End
1	1	0	Boot Mode

Table 7-1: Boot Mode pin settings

The software supplied with this RSK only supports Boot mode using an E8a and HEW. However, hardware exists to enter boot mode manually, do not connect the E8a in this case. Press and hold the SW1/BOOT. The mode pins above are held in their boot states while reset is pressed and released. Release the boot button. The BOOT LED will be illuminated to indicate that the microcontroller is in boot mode.

When neither the E8a is connected nor the board is placed in boot mode (with CNVSS and P5.5 being pulled low during reset) as above, the P5.5 pin is pulled high by a 10k resistor, the P.5.0 pin is pulled high by a 100k resistor and the CNVSS is pulled low by a 100k resistor.

When an E8a is used these three pins are controlled by the E8a.

7.2. Single chip mode

This RSK is configured to always boot in Single Chip mode when the E8a is not connected and the boot switch is not depressed as CNVSS is pulled down by a 100k resistor. Refer to M16C/6NK Group Hardware Manual for details of Single chip mode.

CNVSS	P5.0	P5.5	LSI State after Reset End
0	1	1	Single Chip Mode

Table 7-2: Single Chip Mode pin settings

Chapter 8. Programming Methods

The board is intended for use with HEW and the supplied E8a module. Refer to the M16C/6NK Group Hardware Manual for details of programming the microcontroller without using these tools.

Chapter 9. Headers

9.1. Microcontroller Headers

Table 9-1 to Table 9-4 show the microcontroller pin headers and their corresponding microcontroller connections. The header pins connect directly to the microcontroller pins. * Marked pins are subject to option links.

J1					
Pin	Circuit Net Name	Device Pin	Pin	Circuit Net Name	Device Pin
1	CAN1OUT	99	2	CAN1IN	100
3	DA1	1	4	DA0	2
5	TXD2	3	6	RXD2	4
7	CLK3	5	8	BYTE	6
9	E8_CNVSS	7	10	CON_XCIN	8
11	CON_XCOUT	9	12	RESn	10
13	CON_XOUT	11	14	GROUND	12
15	CON_XIN	13	16	UC_VCC1	14
17	NMI _n	15	18	INT2	16
19	INT1	17	20	INT0	18
21	TA4IN_Un*	19	22	TA4OUT_Up*	20
23	CAN0IN	21	24	CAN0OUT	22
25	TA2IN_Wn	23	26	TA2OUT_Wp*	24
27	Vn	25	28	CLK2_Vp*	26
29	IIC_SCL_RXD2*	27	30	IICSDA_TXD2*	28

Table 9-1: J1

J2					
Pin	Circuit Net Name	Device Pin	Pin	Circuit Net Name	Device Pin
1	PTTX	29	2	PTRX	30
3	PTCK	31	4	E8_BUSY	32
5	TXD0	33	6	RXD0	34
7	CLK0	35	8	CTSRTS	36
9	RDY	37	10	ALE	38
11	E8_EPM	39	12	UD	40
13	TRST _n	41	14	RD _n	42
15	WRH _n	43	16	WRL _n _WR _n	44
17	A23 _n _CS0 _n	45	18	A22_CS1 _n	46
19	A21_CS2 _n	47	20	A20_CS3 _n	48

Table 9-2: J2

J3					
Pin	Circuit Net Name	Device Pin	Pin	Circuit Net Name	Device Pin
1	A19_LED3	49	2	A18_LED2	50
3	A17_LED1	51	2	A16_LED0	52
5	A15_IO7	53	6	A14_IO6	54
7	A13_IO5	55	8	A12_IO4	56
9	A11_IO3	57	10	A10_IO2	58
11	A9_IO1	59	12	UC_VCC2	60
13	A8_IO0	61	14	GROUND	62
15	A7_DLCD7	63	16	A6_DLCD6	64
17	A5_DLCD5	65	18	A4_DLCD4	66
19	A3	67	20	A2	68
21	A1_DLCD0	69	22	A0_DLCD0	70
23	D15	71	24	D14	72
25	D13	73	26	D12	74
27	D11	75	28	D10	76
29	D9	77	30	D8	78

Table 9-3: J3

J4					
Pin	Circuit Net Name	Device Pin	Pin	Circuit Net Name	Device Pin
1	D7	79	2	D6	80
3	D5	81	4	D4	82
5	D3	83	6	D2	84
7	D1	85	8	D0	86
9	AN7_CAN1STBn	87	10	AN6_CAN1EN	88
11	AN5_CAN0STBn	89	12	AN4_CAN0EN	90
13	AN3	91	14	AN2	92
15	AN1	94	16	AVss	94
17	ADPOT_AN0	96	18	CON_AVREF	96
19	CON_AVCC	97	20	ADTRG	99

Table 9-4: J4

9.2. Application Headers

Table 9-5 and Table 9-6 below show the standard application connections. * Marked pins are subject to option links.

JA1									
Pin	Generic Header Name		RSK Signal Name	Device Pin	Pin	Header Name		RSK Signal Name	Device Pin
1	Regulated Supply 1		5V		2	Regulated Supply 1		GROUND	
3	Regulated Supply 2		3V3		4	Regulated Supply 2		GROUND	
5	Analogue Supply		AVcc	97	6	Analogue Supply		AVss	94
7	Analogue Reference		AVref	96	8	ADTRG		ADTRG	98
9	ADC0	I0	ADPot_AN0*	95	10	ADC1	I1	AN1	93
11	ADC2	I2	AN2	92	12	ADC3	I3	AN3	91
13	DAC0		DA0	2	14	DAC1		DA1	1
15	IOPort		A8_IO_0	61	16	IOPort		A9_IO_1	59
17	IOPort		A10_IO_2	58	18	IOPort		A11_IO_3	57
19	IOPort		A12_IO_4	56	20	IOPort		A13_IO_5	55
21	IOPort		A14_IO_6	54	22	IOPort		A15_IO_7	53
23	Interrupt	IRQAEC	D13_INT3	73	24	I ² C Bus - (3rd pin)		NC	-
25	I ² C Bus		IIC_SDA*	28	26	I ² C Bus		IIC_SCL*	27

Table 9-5: JA1 Standard Generic Header

JA2									
Pin	Header Name		RSK Signal Name	Device Pin	Pin	Header Name		RSK Signal Name	Device Pin
1	Reset		RESn	10	2	External Clock Input		EXTAL	-
3	Interrupt		NMIIn	15	4	Regulated Supply 1		Vss1	
5	SPARE		-	-	6	Serial Port		TxD0	33
7	Interrupt		INT0	18	8	Serial Port		RxD0	34
9	Interrupt		INT1	17	10	Serial Port		CLK0	35
11	Motor control		UD	40	12	Serial Port Handshake		CTSRTS	36
13	Motor control		Up*	20	14	Motor control		Un*	19
15	Output		Vp*	26	16	Motor control		Vn	25
17	Input		Wp*	24	18	Motor control		Wn*	23
19	Output		TA2OUT*	23	20	Output		TA4OUT	20
21	Input		TA2IN*	20	22	Input		TA4IN	19
23	Open drain		INT2	16	24	Tristate Control		TRSTn	41
25	SPARE		-		26	SPARE		-	

Table 9-6: JA2 Standard Generic Header

Table 9-7 to Table 9-9 below show the optional generic header connections. * Marked pins are subject to option links.

JA3							
Pin	Header Name	RSK Signal Name	Device Pin	Pin	Header Name	RSK Signal Name	Device Pin
1	A0	A0	70	2	A1	A1	69
3	A2	A2	68	4	A3	A3	67
5	A4	A4	66	6	A5	A5	65
7	A6	A6	64	8	A7	A7	63
9	A8	A8	61	10	A9	A9	59
11	A10	A10	58	12	A11	A11	57
13	A12	A12	56	14	A13	A13	55
15	A14	A14	54	16	A15	A15	53
17	D0	D0	86	18	D1	D1	85
19	D2	D2	84	20	D3	D3	83
21	D4	D4	82	22	D5	D5	81
23	D6	D6	80	24	D7	D7	79
25	RDn	RDn	42	26	WRn	WRn	44
27	CSan	A23_CS0n	45	28	CSbn	CS1n	46
29	D8	D8	78	30	D9	D9	77
31	D10	D10	76	32	D11	D11	75
33	D12	D12	74	34	D13	D13	73
35	D14	D14	72	36	D15	D15	71
37	A16	A16	52	38	A15	A15	51
39	A18	A18	50	40	A19	A19	49
41	A20	A20	48	42	A21	A21	47
43	A22	A22	46	44	SDCLK	---	---
45	CScn	CS2n	47	46	ALE	ALE	38
47	HWRn	WRHn	43	48	LWRn	WRLn	44
49	CASn	---	---	50	RASn	---	---

Table 9-7: JA3 Optional Generic Header

JA5									
Pin	Header Name		RSK Signal Name	Device Pin	Pin	Header Name		RSK Signal Name	Device Pin
1	ADC4	I4	AN4*	90	2	ADC5	I5	AN5*	89
3	ADC6	I6	AN6*	88	4	ADC7	I7	AN7*	97
5	CAN		CAN0OUT	22	6	CAN		CAN0IN	21
7	CAN		CAN1OUT	99	8	CAN		CAN1IN	100
9	Reserved				10	Reserved			
11	Reserved				12	Reserved			
13	Reserved				14	Reserved			
15	Reserved				16	Reserved			
17	Reserved				18	Reserved			
19	Reserved				20	Reserved			
21	Reserved				22	Reserved			
23	Reserved				24	Reserved			

Table 9-8: JA5 Optional Generic Header.

JA6									
Pin	Header Name		RSK Signal Name	Device Pin	Pin	Header Name		RSK Signal Name	Device Pin
1	DMA		---	---	2	DMA		DACK	--
3	DMA		---	---	4	Standby (Open drain)		STBYn	---
5	Host Serial	SCIdTX	RS232TX	---	6	Host Serial	SCIdRX	RS232RX	---
7	Serial Port		RXD2*	27	8	Serial Port		TxD2*	28
9	Serial Port	Synchronous	TXD3*	3	10	Serial Port		CLK2	26
11	Serial Port	Synchronous	CLK3	5	12	Serial Port	Synchronous	RxD3*	4
13	Reserved				14	Reserved			
15	Reserved				16	Reserved			
17	Reserved				18	Reserved			
19	Reserved				20	Reserved			
21	Reserved				22	Reserved			
23	Reserved				24	Reserved			
25	Reserved				26	Reserved			

Table 9-9: JA6 Optional Generic Header

Table 9-10 below shows the CAN connections

J14			
Pin	Function	Signal Name	Device Pin
1	CAN0 Positive	CAN0H	21
2	GROUND		
3	CAN0 Negative	CAN0L	22
J15			
Pin	Function	Signal Name	Device Pin
1	CAN1 Positive	CAN1H	100
2	GROUND		
3	CAN1 Negative	CAN1L	99

Table 9-10: CAN Headers

Chapter 10. Code Development

10.1. Overview

Note: For all code debugging using Renesas software tools, the RSK board must be connected to a PC USB port via an E8a. An E8a is supplied with the RSK product.

10.2. Mode Support

HEW connects to the Microcontroller and programs it via the E8a. Mode support is handled transparently to the user.

10.3. Breakpoint Support

HEW supports breakpoints on the user code, both in RAM and ROM.

Double clicking in the breakpoint column in the code sets the breakpoint. Breakpoints will remain unless they are double clicked to remove them.

10.4. Memory Map

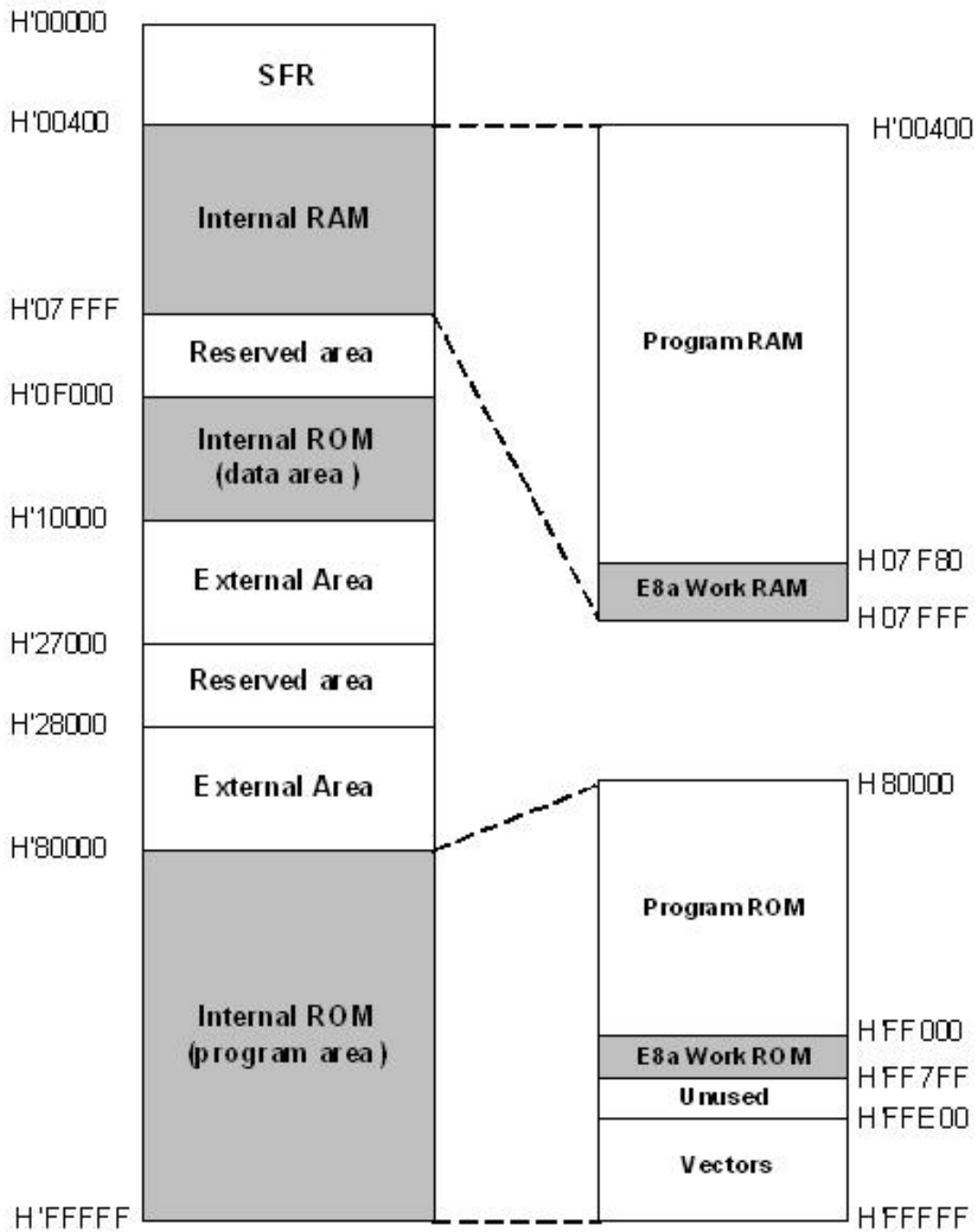

Figure 10-1: Memory Map

Chapter 11. Component Placement

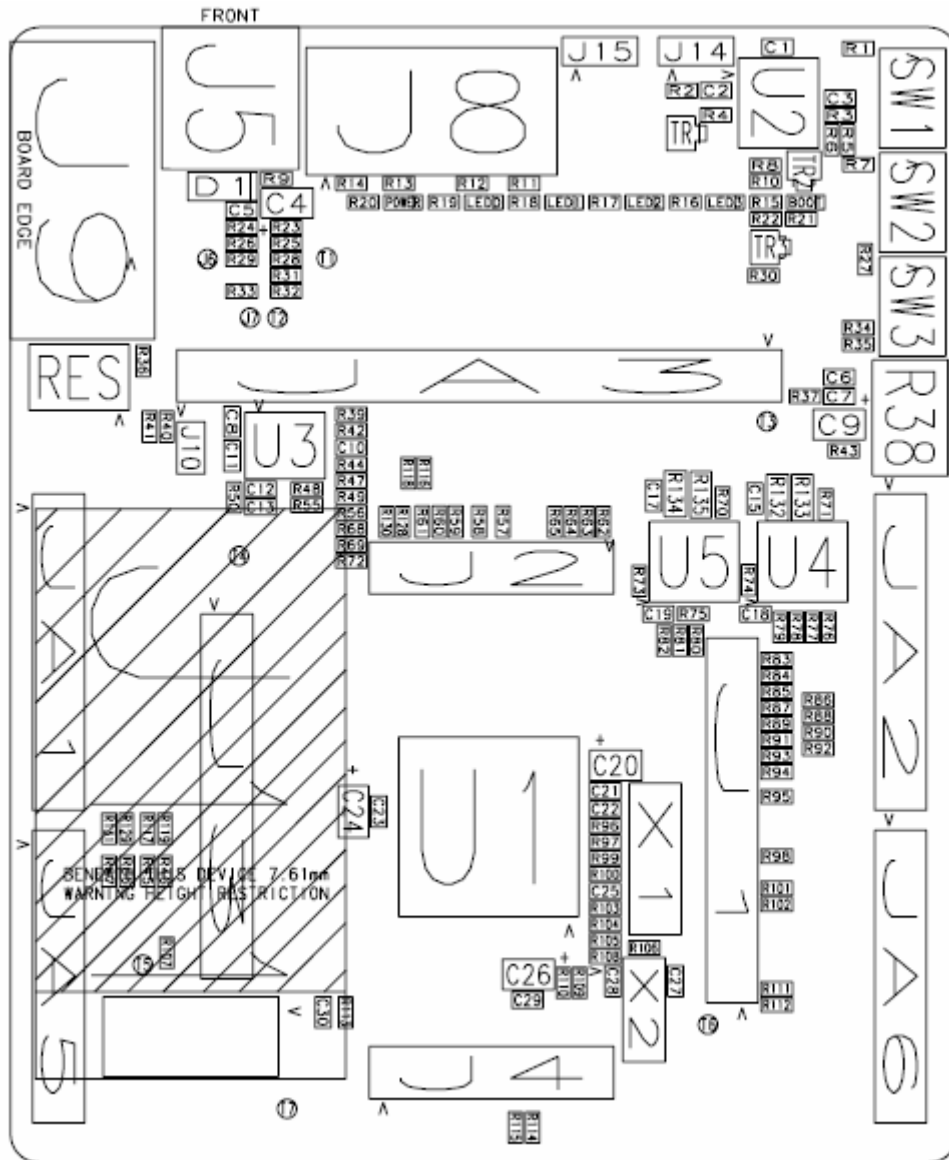

Figure 11-1: Component Placement

Chapter 12. Additional Information

For details on how to use High-performance Embedded Workshop (HEW, refer to the HEW manual available on the CD or from the web site.

For information about the M16C/6NK series microcontrollers refer to the M16C/6NK Group Hardware Manual

For information about the M16C/6NK assembly language, refer to the M16C Series Software Manual.

Online technical support and information is available at: http://www.renesas.com/renesas_starter_kits

Technical Contact Details

America: techsupport.rta@renesas.com

Europe: tools.support.eu@renesas.com

Japan: csc@renesas.com

General information on Renesas Microcontrollers can be found on the Renesas website at: <http://www.renesas.com/>

Renesas Starter Kit for M16C/6NK

User's Manual

Publication Date Rev.02.00 30.OCT.2007

Published by: **Renesas Technology Europe Ltd.**

Duke's Meadow, Millboard Road, Bourne End

Buckinghamshire SL8 5FH, United Kingdom

©2007 Renesas Technology Europe and Renesas Solutions Corp., All Rights Reserved.

Renesas Starter Kit for M16C/6NK
User's Manual

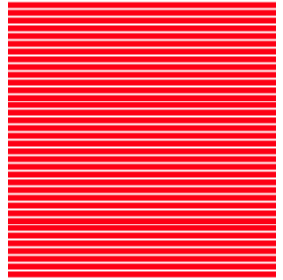

Renesas Technology Europe Ltd.
Duke's Meadow, Millboard Road, Bourne End
Buckinghamshire SL8 5FH, United Kingdom